

An Introduction to Fluorescence Spectroscopy

User Assistance
PerkinElmer Ltd
Post Office Lane
Beaconsfield
Buckinghamshire
HP9 1QA

Printed in the United Kingdom.

Notices

The information contained in this document is subject to change without notice. PerkinElmer makes no warranty of any kind with regard to the material, including, but not limited to, the implied warranties of merchantability and fitness for a particular purpose.

PerkinElmer shall not be liable for errors contained herein for incidental consequential damages in connection with furnishing, performance or use of this material.

Copyright Information

This document contains proprietary information that is protected by copyright. All rights are reserved. No part of this publication may be reproduced in any form whatsoever or translated into any language without the prior, written permission of PerkinElmer, Inc.

Copyright © 2000 PerkinElmer, Inc.

Trademarks

Registered names, trademarks, etc. used in this document, even when not specifically marked as such, are protected by law.

PerkinElmer is a registered trademark of PerkinElmer, Inc.

Table of Contents

Table of Contents.....	3
Luminescence and the nature of light.....	5
Fluorescence.....	7
Phosphorescence.....	11
Light scattering.....	14
Rayleigh-Tyndall scattering.....	14
Raman scattering.....	14
Quantitation.....	16
Sensitivity.....	18
Instrumental sensitivity.....	18
Method sensitivity.....	18
Absolute sensitivity.....	18
Instrumentation.....	21
General.....	21
Light sources.....	22
Wavelength selection.....	24
Detectors.....	25
Read-out devices.....	26
Sample holders.....	26
Problems of high blank values.....	28
Cuvettes.....	28
Solvents and Reagents.....	28
Other contaminants.....	29
Working with dilute solutions.....	30
General.....	30
Adsorption.....	30
Photo-decomposition.....	31
Oxidation.....	31
Factors affecting quantitative accuracy.....	32
Non-linearity.....	32
Temperature effects.....	32
pH effects.....	33
Inner-filter effects.....	33
Quenching.....	33
References.....	34

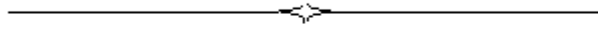

Luminescence and the nature of light

A hot body that emits radiation solely because of its high temperature is said to exhibit incandescence. All other forms of light emission are called luminescence.

When luminescence occurs, the system loses energy and if the emission is to be continuous, some form of energy must be supplied from elsewhere. Thus the radioluminescence emitted from a luminous clock face is supplied by high energy particles from the radioactive material in the phosphor and the electroluminescence of a gas discharge lamp is derived from the passage of an electric current through an ionised gas. Other such phenomena include chemiluminescence, derived from the energy of a chemical reaction, and this is called bioluminescence when the reactions take place within living organisms, for example, glow-worms and fireflies.

When the external energy supply is by means of the absorption of infrared, visible or ultraviolet light, the emitted light is called photoluminescence and this is the process that takes place in any fluorimetric analysis.

To account adequately for the processes of absorption and emission of light, it is necessary to assume that radiant energy can only be absorbed in definite units, or *quanta*. The energy, E , carried by any one quantum is proportional to its frequency of oscillation, that is

$$E = h\nu = \frac{hc}{\lambda} \quad \text{ergs}$$

where ν is the frequency, λ the related wavelength and h = Planck's constant (6.624×10^{-27} ergs/seconds).

The energy of a single quantum is too small for convenience and it is usual to talk of the energy associated with N quanta (where $N = 6.023 \times 10^{23}$ the number of single molecules in a gram molecule), which is called an einstein. Thus, if in a photochemical reaction one molecule reacts for each quantum absorbed, then the absorption of one einstein is sufficient energy for the reaction of one gram mole. Since the amount of energy per einstein is proportional to the frequency of the radiation, it varies enormously over the range of the electro-magnetic spectrum, as shown in the following table.

Radiation	Approximate sizes of Quanta				
	$\nu(\text{cm})$ (typical values)	Wave-number (μm^{-1})	Size of quantum (electron volts)	Size of einstein (kilogram calories)	Absorption or emission of radiation involves
Gamma rays	10^{-10}	10^6	1.2×10^6	2.9×10^7	Nuclear reactions
X-rays	10^{-8}	10^4	1.2×10^4	2.9×10^5	Transitions of inner atomic electrons
Ultraviolet	10^{-5}	10^1	1.2×10^1	2.9×10^2	Transitions of outer atomic electrons
Visible	4×10^{-5} 8×10^{-5}	2.5 1.25	3.1 1.6	7.1×10^1 3.6×10^1	
Infrared	10^{-3}	10^{-1}	1.2×10^{-1}	2.9	Molecular vibrations
Far infrared	10^{-3}	10^{-2}	1.2×10^{-2}	2.9×10^{-1}	Molecular rotations
Radar	10^1	10^{-5}	1.2×10^{-5}	2.9×10^{-4}	Oscillation of mobile or free electrons
Long radio waves	10^5	10^{-9}	1.2×10^{-9}	2.9×10^{-8}	

The ultraviolet and visible regions of the spectrum are of most interest in fluorimetry and absorption in these regions causes the excitation of the outermost electrons of the molecule. The energy associated with radiation of this frequency is quite high, around 100 kilogram calories per einstein, and is sometimes sufficient to break down the absorbing molecules, as for instance with the fading of dyes by the action of sunlight.

The absorption of light results in the formation of excited molecules which can in turn dissipate their energy by decomposition, reaction, or re-emission. The efficiency with which these processes take place is called the quantum efficiency and in the case of photoluminescence can be defined as:

$$\Phi_E = \frac{\text{einsteins emitted}}{\text{einsteins absorbed}} \quad \text{or} \quad \frac{\text{No. of quanta emitted}}{\text{No. of quanta absorbed}}$$

and never exceeds unity.

Fluorescence

At room temperature most molecules occupy the lowest vibrational level of the ground electronic state, and on absorption of light they are elevated to produce excited states. The simplified diagram below shows absorption by molecules to produce either the first, S₁, or second S₂, excited state (Figure 1).

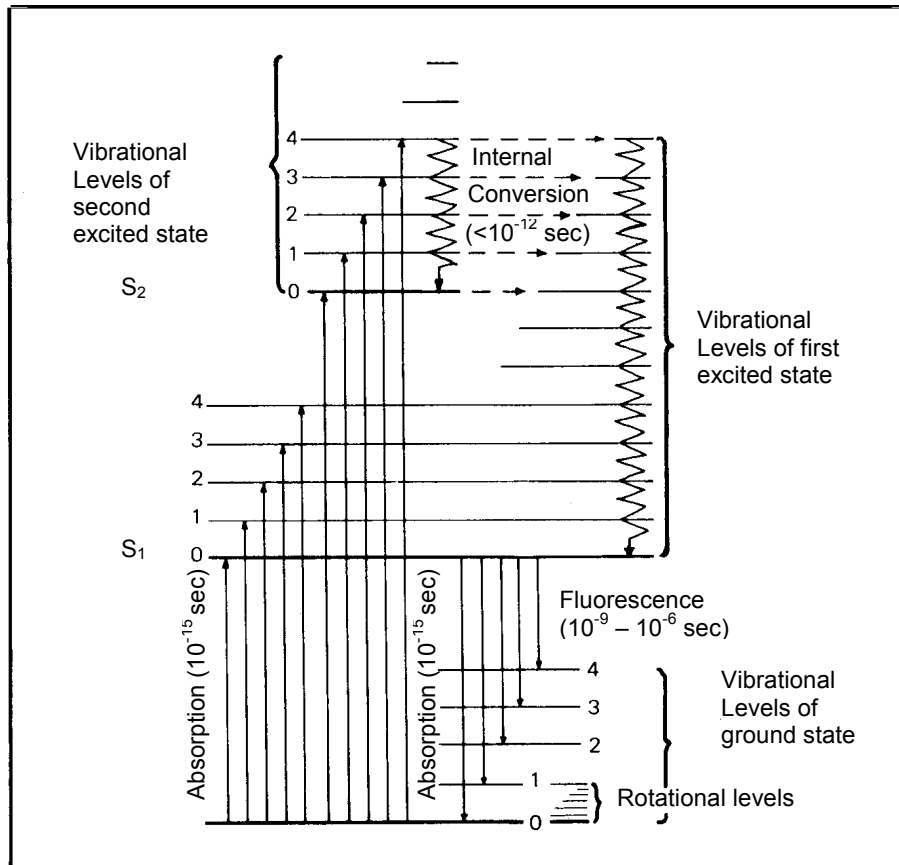

Figure 1 Transitions giving rise to absorption and fluorescence emission spectra

Excitation can result in the molecule reaching any of the vibrational sub-levels associated with each electronic state. Since the energy is absorbed as discrete quanta, this should result in a series of distinct absorption bands. However, the simple diagram above neglects the rotational levels associated with each vibrational level and which normally increase the number of possible absorption bands to such an extent that it becomes impossible to resolve individual transitions.

Therefore, most compounds have broad absorption spectra except for those where rotational levels are restricted (for example, planar, aromatic compounds).

Having absorbed energy and reached one of the higher vibrational levels of an excited state, the molecule rapidly loses its excess of vibrational energy by collision and falls to the lowest vibrational level of the excited state. In addition, almost all molecules occupying an electronic state higher than the second undergo internal conversion and pass from the lowest vibrational level of the upper state to a higher vibrational level of a lower excited state which has the same energy. From there the molecules again lose energy until the lowest vibrational level of the first excited state is reached.

From this level, the molecule can return to any of the vibrational levels of the ground state, emitting its energy in the form of fluorescence. If this process takes place for all the molecules that absorbed light, then the quantum efficiency of the solution will be a maximum, unity. If, however, any other route is followed, the quantum efficiency will be less than one and may even be almost zero.

One transition, that from the lowest vibrational level in the ground electronic state to the lowest vibrational level in the first excited state, the 0 - 0 transition, is common to both the absorption and emission phenomena, whereas all other absorption transitions require more energy than any transition in the fluorescence emission. We can therefore expect the emission spectrum to overlap the absorption spectrum at the wavelength corresponding to the 0 - 0 transition and the rest of the emission spectrum to be of lower energy, or longer wavelength (Figure 2).

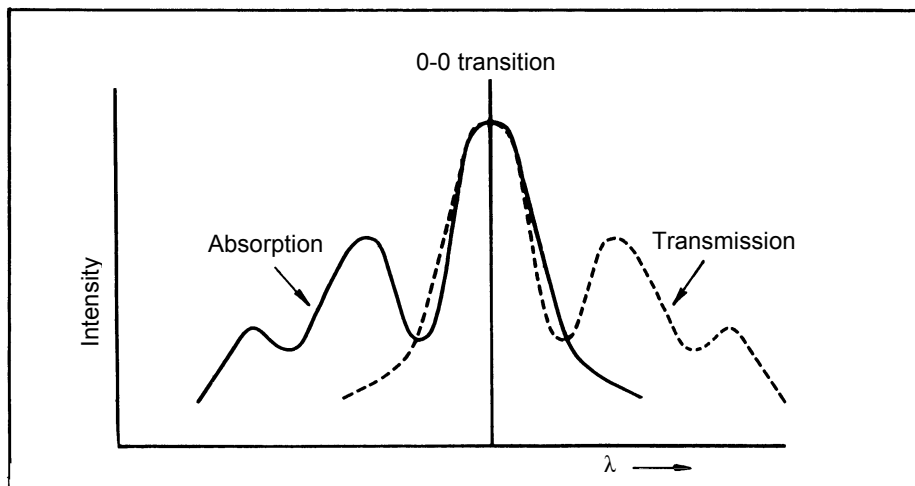

Figure 2 Idealised absorption and emission spectra

In practice, the 0-0 transitions in the absorption and emission spectra rarely coincide exactly, the difference representing a small loss of energy by interaction of the absorbing molecule with surrounding solvent molecules.

The absorption of energy to produce the first excited state does not perturb the shape of the molecule greatly and this means that the distribution of vibrational levels is very similar in both the ground and first excited states. The energy differences between the bands in the emission spectrum will be similar to those in the absorption spectrum and frequently the emission spectrum will be approximate to a mirror image of the absorption spectrum. Since the emission of fluorescence always takes place from the lowest vibrational level of the first excited state, the shape of the emission spectrum is always the same, despite changing the wavelength of exciting light.

A plot of emission against wavelength for any given excitation wavelength is known as the emission spectrum. If the wavelength of the exciting light is changed and the emission from the sample plotted against the wavelength of exciting light, the result is known as the excitation spectrum. Furthermore, if the intensity of exciting light is kept constant as its wavelength is changed, the plot of emission against exciting wavelength is known as the corrected excitation spectrum.

The quantum efficiency of most complex molecules is independent of the wavelength of exciting light and the emission will be directly related to the molecular extinction coefficient of the compound; in other words, the corrected excitation spectrum of a substance will be the same as its absorption spectrum.

Phosphorescence

In the production of excited states by promotion of an electron into a higher orbital, the direction of the spin of the electron is preserved. Since most molecules have an even number of electrons and these are normally arranged in pairs of opposite spin, the promotion of an electron does not disturb this parity.

However, it is possible for the spin of the promoted electron to be reversed so that it is no longer paired and the molecule has two independent electrons of the same spin in different orbitals. Quantum theory predicts that such a molecule can exist in three forms of very slightly differing, but normally indistinguishable energy, and the molecule is said to exist in a triplet state. The indirect process of conversion from the excited state produced by absorption of energy, the singlet state, to a triplet state, is known as intersystem crossing (Figure 3) and can occur in many substances when the lowest vibrational level of the excited singlet state, S_1 , has the same energy level as an upper vibrational level of the triplet state.

Direct transition from the ground state, usually a singlet state, for a molecule with an even number of electrons, to an excited triplet state is theoretically forbidden, which means that the reverse transition from triplet to ground state will be difficult. Thus, while the transition from an excited singlet state, for example, S_1 , to the ground state with the emission of fluorescence can take place easily and within 10^{-9} - 10^{-6} seconds, the transition from an excited triplet state to the ground state with the emission of phosphorescence requires at least 10^{-4} seconds and may take as long as 10^2 seconds. This delay was once used as the characterisation of phosphorescence, but a more precise definition requires that phosphorescence be derived from transitions directly from the triplet state to the ground state.

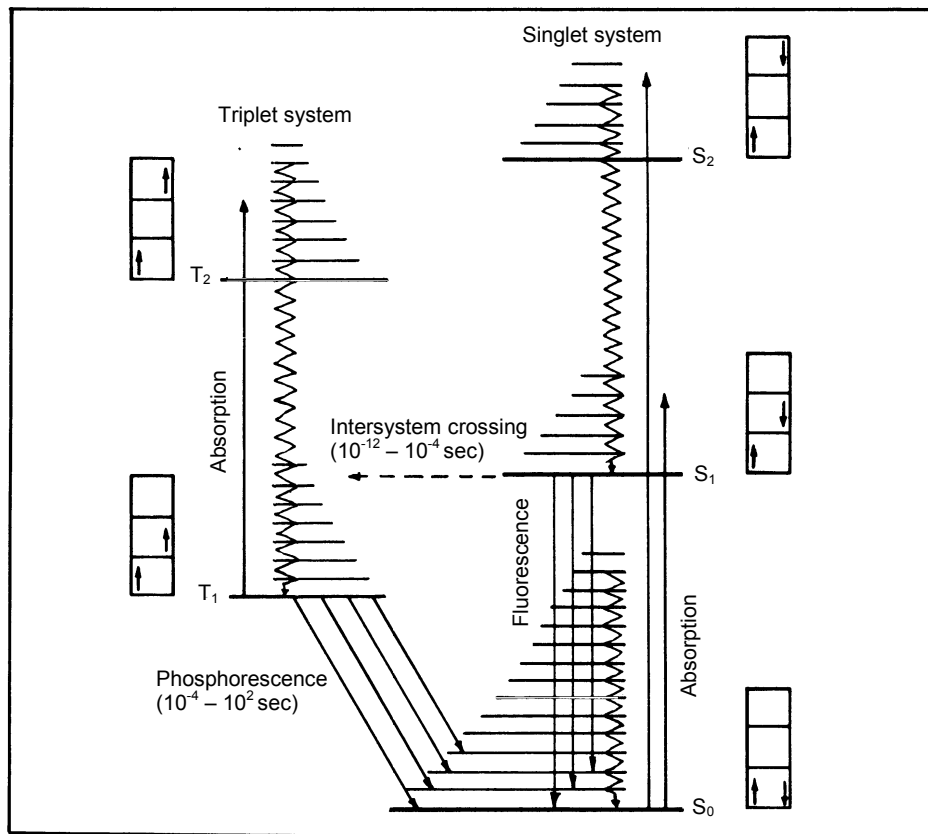

Figure 3 Transition from the excited singlet state (S_1) to the triplet state (intersystem crossing)

The triplet state of a molecule has a lower energy than its associated singlet state so that transitions back to the ground state are accompanied with the emission of light of lower energy than from the singlet state. Therefore, we would typically expect phosphorescence to occur at longer wavelengths than fluorescence (Figure 4).

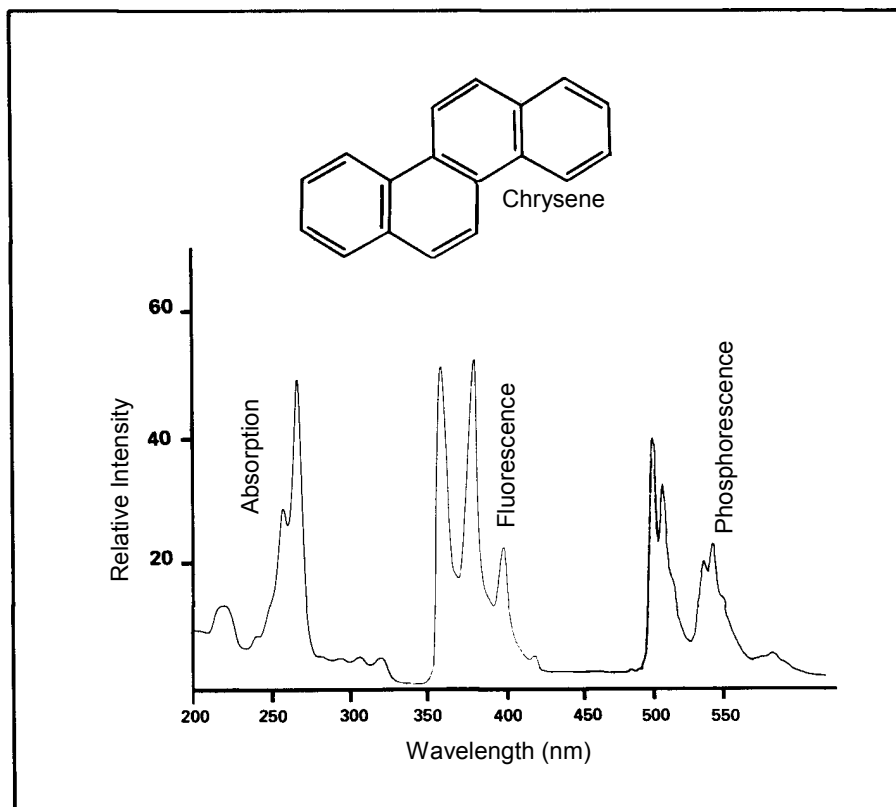

Figure 4 Relative position of absorption, fluorescence and phosphorescence bands of chrysene

Since molecules occupy triplet states for relatively long periods, they can easily lose their energy by means other than phosphorescence. They are very susceptible to collisions with solvent molecules. Solute molecules with unpaired electrons, such as oxygen, are very effective at destroying triplet states even at low concentrations. Therefore, phosphorescence in solution at room temperature is a rare phenomenon, but by dispersing the sample in a rigid matrix or freezing the solution to a low temperature, it can be observed from many compounds.

Light scattering

Rayleigh-Tyndall scattering

Incident radiation is not only absorbed or transmitted by the sample but is also scattered in all directions. The scattering takes place either from the molecules themselves (Rayleigh scattering) or from small particles in colloidal suspension (Tyndall scattering). Both types of scattering mean that incident radiation is collected together with fluorescence and, unless adequate precautions are taken to separate the fluorescence, inaccurate results will be obtained.

Rayleigh-Tyndall scattering will limit the sensitivity of an assay where fluorescence takes place at a wavelength close to the excitation wavelength, since total separation is impossible.

Raman scattering

During the Rayleigh scattering process, some of the incident energy can be abstracted and converted into vibrational and rotational energy. The resulting energy scattered is therefore of lower energy and longer wavelength than the incident radiation. The result is a weak emission which may interfere or be confused with the fluorescence of the sample.

Since the amount of energy abstracted is always constant, Raman bands appear separated from the incident radiation by the same frequency difference, irrespective of the wavelength of the exciting light, as shown in the following table. If, therefore, the Raman band of the solvent coincides with the fluorescence emission of the solute, separation can be achieved by changing the excitation wavelength to a lower value; hence the Raman band will also be lowered. Since the wavelength of fluorescence emission is independent of exciting wavelength, the fluorescence will be separated from the Raman scatter.

Raman scatter is only important at high sensitivity since the phenomenon is weak but must always be borne in mind. The Raman emission of some solvents is quite complex and an emission spectrum of the solvent blank should always be run prior to the analysis.

Solvent	Position of Raman bands when excited at selected wavelength			
	Excitation wavelength 313 nm	Excitation wavelength 366 nm	Excitation wavelength 405 nm	Excitation wavelength 436 nm
Water	350	418	469	511
Acetonitrile	340	406	457	504
Cyclohexane	344	409	458	499
Chloroform	346	411	461	502

All solvents containing hydrogen atoms linked to either carbon or oxygen show a Raman band shifted approximately 3000 cm^{-1} from the exciting radiation.

Quantitation

The fraction of a parallel beam of light absorbed by a sample is independent of the intensity of the incident beam and is related to the concentration of the absorbing species by the familiar Beer-Lambert Law:-

$$\frac{I_0}{I} = e^{-Ecl} \quad (1)$$

Normally written as:

$$\log_{10} \frac{I_0}{I} = Ecl$$

where

I = intensity of transmitted light

I_0 = intensity of incident light

E = molecular extinction coefficient

c = concentration in gm moles/L⁻¹

l = pathlength of sample

and the quantity $\log_{10} \frac{I_0}{I}$ is known as the absorbance or optical density of the sample.

Absorption spectra are simply a plot of absorbance against wavelength for any sample.

The intensity of fluorescence emission of weakly absorbing, dilute samples is related to the molecular extinction coefficient by the relation:

$$F_f = I_0 (2.303 E cl) \Phi_f \quad (2)$$

and so the intensity of fluorescence emission is directly proportional to the intensity of the incident radiation. These two equations explain the difference in sensitivity between absorption and fluorimetric procedures. Sensitivity in absorption measurements is limited by the ability of the instrument to discriminate between the two nearly equal signals due to I and I_0 , and the detection limit for even the most favorable cases rarely exceeds 10^{-8} moles.

Conversely, fluorimetric instruments are limited only by the intensity of exciting light and the ability to detect low light levels, so under ideal conditions concentrations of 10^{-12} moles can be measured.

Equation (2) only holds for dilute samples and it is possible to calculate the concentration level (C_{\max}) above which non-linearity is observed from:

$$C_{\max} = \frac{0.05}{El} \quad (3)$$

It is most important to establish the concentration at which a plot of fluorescence emission against concentration becomes non-linear either by calculation, (3), or by measurement of a suitable range of standards. Direct interpolation of concentrations outside this limit will give inaccurate results.

Sensitivity

It is relatively easy to define the sensitivity of a UV-VIS spectrometer since there is an absolute unit of measurement called an Absorbance value. In fluorescence and phosphorescence spectroscopy there is no such fixed unit or standard, hence there are a wide variety of ways with which sensitivity has been described. Since the technique is primarily used for its inherent sensitivity and since to a great extent the sensitivity of a fluorescence assay is dependent on the instrument in use, some means of comparing instrument performance is clearly needed.

Instrumental sensitivity

Instrumental sensitivity can be expressed as (a) defining the signal to noise ratio of the instrument at a particular set of conditions or (b) the minimum detectable quantity of a particular compound at a particular set of conditions.

Method sensitivity

Method sensitivity or limit of detection is defined in trace analysis as that concentration which yields an instrument response, two standard deviations above the background signal.

Absolute sensitivity

Absolute sensitivity expressed in terms of the spectral properties of the material, for example, quantum yield, extinction coefficient, and is better expressed in a form that is independent of the instrument used to make the measurement.

For many years, instrument sensitivity was defined as that concentration of a standard substance which is required to produce a signal equal to the noise at a specified time constant. This definition is not only dependent upon the luminescence properties of the compound and performance of the instrument but also from the fluorescence from impurities in the solvent and sample, fluorescence from the cuvettes and Raman scattering of the solvent.

Although the highest purity cuvettes can be used and the effect of the Raman band minimized by suitable choice of solvent and/or wavelength, the limit of detection may be totally different if different quality solute and solvent has been used. In other words, the limit of detection is likely to be blank limited. The usual sample often quoted is a solution of quinine sulfate in 0.1 N H₂SO₄. Many manufacturers specify sensitivity in the parts per trillion range; however, it has been shown that at those levels, non-linearity of the plot of intensity against concentration occurs.

Because of these difficulties, an alternative approach to citing instrument sensitivity has recently become more popular - that of measurement of the signal to noise ratio of Raman bands of solvents such as water, alcohols or hydrocarbons. Parker was the first to suggest that the Raman signal from a suitable solvent provided a useful test of instrumental sensitivity. The advantages of the test are; (a) independence of the chemistry since it measures the properties of the solvent; (b) water, which is usually used, can be obtained virtually free of fluorescent impurities, the principal Raman band occurring at 3380cm⁻¹; (c) ease of application and sensitivity; (d) versatility since it can be applied at any wavelength between 200 and 500 nm.

The procedure involves determining the signal to noise ratio at particular slit width (usually 5 or 10 nm), response time, with the excitation and emission monochromators set to appropriate wavelengths to detect the Raman band. The wavelength commands used are 350 nm excitation and 397 nm emission. The following table lists some of the Raman peak maxima for water at particular excitation wavelengths.

Excitation (nm)	Raman emission (nm)
200	212
250	272
300	337
350	397
400	463
450	530
500	602

In spite of the intrinsic advantage of the Raman test, both it and the level of detection method suffer from the disadvantage that they are measured at one set of wavelengths. In practice, instruments from manufacturers differ in their relative response at different wavelengths. In addition, the optical performance tends to degrade with time, particularly below 300 nm and by different amounts in different instruments. Having commented on these differences however, there is no ideal method which can be used to express sensitivity to compare different instruments. The most suitable is the Raman band test providing the information containing the two constant spectral bandpass and scan rate.

Instrumentation

General

All fluorescence instruments contain three basic items: a source of light, a sample holder and a detector. In addition, to be of analytical use, the wavelength of incident radiation needs to be selectable and the detector signal capable of precise manipulation and presentation (Figure 5). In simple filter fluorimeters, the wavelengths of excited and emitted light are selected by filters which allow measurements to be made at any pair of fixed wavelengths.

Simple fluorescence spectrometers have a means of analysing the spectral distribution of the light emitted from the sample, the fluorescence emission spectrum, which may be by means of either a continuously variable interference filter or a monochromator. In more sophisticated instruments, monochromators are provided for both the selection of exciting light and the analysis of sample emission. Such instruments are also capable of measuring the variation of emission intensity with exciting wavelength, the fluorescence excitation spectrum.

In principle, the greatest sensitivity can be achieved by the use of filters, which allow the total range of wavelengths emitted by the sample to be collected, together with the highest intensity source possible. In practice, to realize the full potential of the technique, only a small band of emitted wavelengths is examined and the incident light intensity is not made excessive, to minimize the possible photodecomposition of the sample.

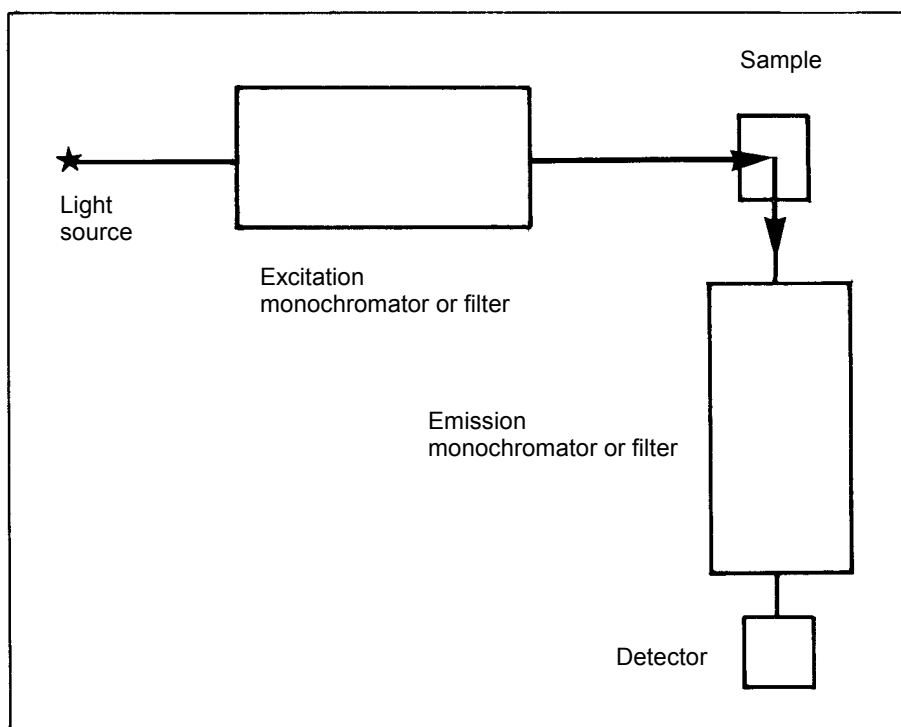

Figure 5 Essential components of a fluorescence spectrometer

Light sources

Commonly employed sources in fluorescence spectrometry have spectral outputs either as a continuum of energy over a wide range or as a series of discrete lines. An example of the first type is the tungsten-halogen lamp and of the latter, a mercury lamp. Mercury lamps are the most commonly employed line sources and have the property that their spectral output depends upon the pressure of the filler gas. The output from a low-pressure mercury lamp is concentrated in the UV range, whereas the most commonly employed lamps, of medium and high pressure, have an output covering the whole UV-visible spectrum.

Although in many cases the output from a line source will be adequate, it is rare that an available line will exactly coincide with the optimum excitation wavelength of the sample. It is therefore advantageous to employ a source whose output is a continuum and the most commonly employed type is the xenon arc. Xenon arc sources can be operated either on a continuous DC basis or stroboscopically; the latter method offers advantages in the size and cost of lamps. The output is essentially a continuum on which are superimposed a number of sharp lines, allowing any wavelength throughout the UV-visible region of the spectrum to be selected (Figure 6).

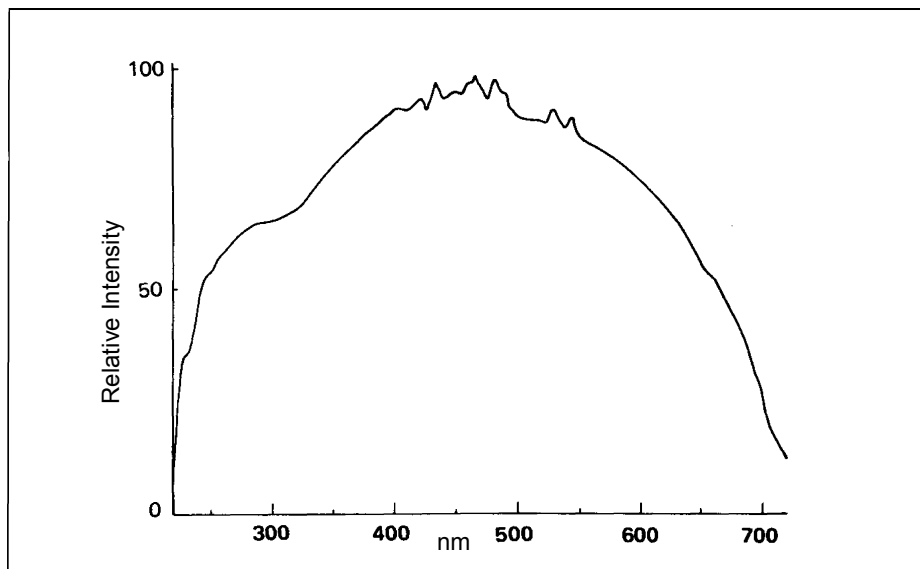

Figure 6 Emission spectrum of xenon lamp used in the PerkinElmer LS Series

Arc lamps are inherently more unstable than discharge sources and for long term stability a method of compensating for drift is advisable. The most satisfactory method of doing this is to split the excitation energy so that a small portion is led to a reference detector. The signal from this reference detector is ratioed with the signal from the detector observing the sample. Such a ratio-recording system is therefore independent of changes in the source intensity.

All sources of UV radiation will produce ozone from atmospheric oxygen, which should be dispersed, since it is not only toxic, but also absorbs strongly in the region below 300 nm. For this reason, most lamps will be operated in a current of air and, if the supply fan fails, the lamp should be extinguished immediately. Lamps must be handled with great care since fingermarks will seriously decrease the UV output.

Wavelength selection

The simplest filter fluorimeters use fixed filters to isolate both the excited and emitted wavelengths. To isolate one particular wavelength from a source emitting a line spectrum, a pair of cut-off filters are all that is required. These may be either glass filters or solutions in cuvettes. The emission filter must be chosen so that the Rayleigh-Tyndall scattered light is obscured and the light emitted by the sample transmitted. To avoid high blanks it may also be necessary to filter out any Raman scatter.

Recently, interference filters having high transmission ($\approx 40\%$) of a narrow range (10 – 15 nm) of wavelengths have become available and it is possible to purchase filters with a maximum transmission at any desired wavelength. UV filters of this type, however, are expensive and of limited range. A simple filter system is acceptable for much quantitative work, particularly where sufficient chemistry has been carried out to eliminate interfering compounds.

However, it is useful to be able to scan the emission from the sample to check for impurities and optimize conditions. A convenient method is to make use of a continuous interference filter so that an emission spectrum can be recorded, at least over the visible region of the spectrum.

A further refinement would be to use monochromators to select both the excitation and emission wavelengths. Most modern instruments of this type employ diffraction grating monochromators for this purpose. Such a fluorescence spectrometer is capable of recording both excitation and emission spectra and therefore makes full use of the analytical potential of the technique.

If monochromators are employed, it should be possible to change the slit width of both the excitation and emission monochromators independently. Many analyses will not require high resolution (essentially corresponding to high selectivity) and greater sensitivity will be obtained with wide slit widths. Conversely, to record the fine structure in the emission of, for example,, polyaromatic hydrocarbons or to excite selectively one compound in the presence of another, narrow slit widths will be necessary, and sensitivity will be sacrificed.

Detectors

All commercial fluorescence instruments use photomultiplier tubes as detectors and a wide variety of types are available. The material from which the photocathode is made determines the spectral range of the photomultiplier and generally two tubes are required to cover the complete UV-visible range. The S5 type can be used to detect fluorescence out to approximately 650 nm, but if it is necessary to measure emission at longer wavelengths, a special red sensitive, S20, photomultiplier should be employed.

The limit of sensitivity of a photomultiplier is normally governed by the level of dark current (which is the signal derived from the tube with no light falling on it). The dark current is caused by thermal activation and can usually be reduced by cooling the photomultiplier. Another method of minimizing dark current is to use a stroboscopic source since the ratio of dark current to fluorescence will be very small during each high intensity flash. During the periods between flashes when the dark current is relatively high, the photomultiplier output can be disconnected. The overall result is that the dark current no longer becomes the limitation to sensitivity.

The spectral response of all photomultipliers varies with wavelength, but it is sometimes necessary to determine the actual quantum intensity of the incident radiation and a detector insensitive to changes in wavelength is required. A suitable quantum counter can be made from a concentrated solution of Rhodamine 101 in ethylene glycol which has the property of emitting the same number of quanta of light as it absorbs, but over a very wide wavelength range. Thus, by measuring the output of the quantum counter at one wavelength, the number of incident quanta over a wide wavelength range can be measured.

Read-out devices

The output from the detector is amplified and displayed on a readout device which may be a meter or digital display. It should be possible to change the sensitivity of the amplifier in a series of discrete steps so that samples of widely differing concentration can be compared. A continuous sensitivity adjustment is also useful so that the display can be made to read directly in concentration units.

Digital displays are most legible and free from misinterpretation. Improvement in precision is obtained by the use of integration techniques where the average value over a period of a few seconds is displayed as an unchanging signal. Microprocessor electronics provide outputs directly compatible with printer systems and computers, eliminating any possibility of operator error in transferring data.

Sample holders

The majority of fluorescence assays are carried out in solution, the final measurement being made upon the sample contained in a cuvette or in a flowcell. Cuvettes may be circular, square or rectangular (the latter being uncommon), and must be constructed of a material that will transmit both the incident and emitted light. Square cuvettes, or cells will be found to be most precise since the parameters of pathlength and parallelism are easier to maintain during manufacture. However, round cuvettes are suitable for many more routine applications and have the advantage of being less expensive.

The cuvette is placed normal to the incident beam. The resulting fluorescence is given off equally in all directions, and may be collected from either the front surface of the cell, at right angles to the incident beam, or in-line with the incident beam.

Some instruments will provide the option of choosing which collecting method should be employed, a choice based upon the characteristics of the sample. A very dilute solution will produce fluorescence equally from any point along the path taken by the incident beam through the sample. Under these conditions, the right-angled collection method should be used since it has the benefit of minimizing the effect of light scattering by the solution and cell. This is the usual measuring condition in analytical procedures.

Although fluorescence takes place from every point along the light path, only a small fraction of this emission is actually collected by the instrument and transmitted to the detector. The result is that much of the solution does not contribute to the fluorescence emission and the same intensity will be observed from a much smaller volume of solution contained in a microcell whose dimensions more closely match the optical considerations of the instrument (Figure 7).

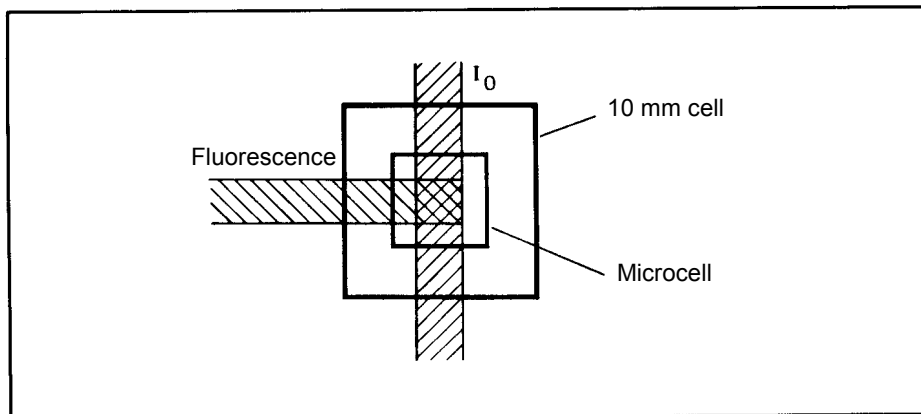

Figure 7 Fluorescence emission from a microcell whose dimensions closely match the optical considerations of the instrument

As the absorbance of the solution increases, the fluorescence emission becomes progressively distorted until a point is reached where little actually penetrates the main bulk of the solution and the fluorescence will be confined to the front surface of the cuvette. Front surface collection will still allow measurements to be made, although the contribution due to light scattered from the cuvette wall will be large. Front surface collection will at least always show emission (possibly distorted) from a fluorescent sample, whereas the fluorescence obtained from 90° collection falls rapidly as the absorbance of the solution increases.

It is possible to dismiss a potential sample as non-fluorescent simply because the concentration is too high. Wherever possible, the absorbance of a completely unknown solution should be measured before attempting a fluorescence check and the concentration adjusted to provide a solution of absorbance <0.1 A.

Problems of high blank values

Cuvettes

One of the advantages of fluorescence procedures compared to equivalent absorption techniques is that routine measurements may usually be carried out in inexpensive test-tubes rather than precision cuvettes without appreciable loss in precision. This benefit is derived from the geometrical layout of simple fluorimeters where only a small central area of the cuvette is actually viewed by the detector, so that the overall dimensions of the cell are less important.

However, this statement needs careful qualification, since the use of laboratory grade test-tubes will result in deviation arising from other sources. Variations in cell wall width can give rise to errors by distorting the lens action of the round cell wall from one cell to another and the native fluorescence of the material used to manufacture the cell will often produce large blank values. Obviously, the cell must be fabricated from a material which will transmit both the excitation and emission wavelengths of interest and, if these are both in the visible region, savings can be made by the use of glass or even plastic sample containers. Only those cells recommended by the manufacturer of the instrument should be employed and every new batch should be carefully checked to make quite sure that their native fluorescence at the analytical wavelength chosen is minimal. Even the highest grades of silica and glass have some fluorescence, although it should not contribute appreciably to routine measurements.

Cells and other glassware used for fluorimetric analysis should be carefully cleaned, preferably by boiling in 50% nitric acid followed by thorough rinsing in distilled water.

Solvents and Reagents

It is essential to examine the quality of solvents periodically since small traces of contaminants may be enough to produce high blank values. If the solvent blank is appreciable it can usually be reduced to a reasonable value by distillation or washing with acid, base or water.

- Water is the most common solvent and deionized-distilled water should always be employed.

- Solvents should not be stored in plastic containers since leaching of organic additives and plasticisers will produce high blank values.
- Fluorescence derived from contaminants should not be confused with the Raman scatter from the solvent itself.
- All other reagents used in the assay should be carefully controlled and high quality grades are to be recommended.
- Reagent blanks should always be carried through the analytical procedure and the actual value of the blank determined before the instrument is re-zeroed.
- High or changed blank values should immediately cast suspicion upon the solvents and reagents employed.

Other contaminants

Soaking of glassware in synthetic detergent solutions is gaining ground in many laboratories as a general method of cleaning. Most commercial preparations are strongly fluorescent. Before use, the fluorescence characteristics of a dilute solution of the detergent should be measured to make quite sure that the fluorescence is minimal at the chosen analytical wavelengths. Inorganic cleansing agents are more suitable for fluorimetric work.

Stopcock grease is another common contaminant with strong native fluorescence. The growth of micro-organisms in buffer or reagent solutions will affect blank values by both their fluorescence and light scattering properties. Filter paper can be another source of contamination due to residues of phenols present from the original wood.

Working with dilute solutions

General

It is widely recognized that dilute solutions are not as stable as concentrated ones. For this reason, it is common practice to store concentrated stock solutions and make dilutions to produce working standards. It would appear that only a small constant fraction of the molecules present are susceptible and that, as solutions are diluted, this constant fraction becomes progressively more significant. Final solutions are always very dilute and should never be stored for long periods. It is good practice to carry out all procedures as quickly as is practicably possible.

Adsorption

Loss of organic substances by adsorption onto the walls of the container becomes particularly troublesome at the sub-microgram level. New glass surfaces should be thoroughly cleaned in acid before use and measurements of aromatic substances in non-polar solvents should be avoided. Often the addition of a small quantity of a polar solvent to a non-polar one will greatly reduce adsorption losses.

Protein precipitation produces a large, freshly prepared, adsorptive surface and choice of precipitation agent is critical to prevent adsorption of the fluorophore with subsequent loss. Each assay may require a specific precipitation agent and analytical procedures should not be changed without investigation.

Photo-decomposition

Fluorimeters employ intense light sources to produce high sensitivity and in some cases the level of incident light may be sufficient to decompose the sample under investigation. A shutter is essential so that the solution is only irradiated during the short period of measurement. The decomposition only occurs at the point where the excitation beam is focused onto the sample and if, after closing and then reopening the excitation shutter, the value of fluorescence rises to the original value, photo-decomposition is almost certainly taking place. This phenomenon is due to the diffusion of unaffected, fresh molecules into the light path whilst the shutter is closed, with subsequent renewal of fluorescence. Photo-decomposition may be reduced by choice of another excitation wavelength or by reducing the excitation intensity by use of narrower slit widths or a neutral density filter.

Oxidation

The presence of trace oxidizing agents, for example, dissolved oxygen or traces of peroxides, can reduce fluorescence intensity.

Factors affecting quantitative accuracy

Non-linearity

The proportional relationship between light absorption and fluorescence emission is only valid for cases where the absorption is small. As the concentration of fluorophore increases, deviations occur and the plot of emission against concentration becomes non-linear. With right-angle viewing, the principal distortion arises from the absorption of the excited light before it can penetrate to the heart of the cell, where the emission produced is accepted by the detector optics.

In cases where it is necessary to work at high concentrations, for example, in some enzyme work using NADH, it is usually possible to increase the linear concentration range by the use of microcuvettes, often without much loss in overall sensitivity. Generally, deviations of this sort are negligible when dealing with solutions of transmission greater than 95 %T at the wavelength of interest, which can be easily checked with an absorption instrument. Other sources of non-linearity are usually associated with the instrument's signal handling (for example, amplifiers) and display (especially meters) systems.

Temperature effects

Changes in temperature affect the viscosity of the medium and hence the number of collisions of the molecules of the fluorophore with solvent molecules. Fluorescence intensity is sensitive to such changes and the fluorescence of many certain fluorophores shows a temperature dependence. In such cases the use of thermostatted cell holders is to be recommended. Normally it is sufficient to work at room temperature with the proviso that any sample procedure involving heating or cooling must also allow sufficient time for the final solution to reach ambient before measurement.

pH effects

Relatively small changes in pH will sometimes radically affect the intensity and spectral characteristics of fluorescence. Accurate pH control is essential and, when particular buffer solutions are recommended in an assay procedure, they should not be changed without investigation. Most phenols are fluorescent in neutral or acidic media, but the presence of a base leads to the formation of nonfluorescent phenate ions. 5 hydroxyindoles, for example, serotonin, show a shift in fluorescence emission maximum from 330 nm at neutral pH to 550 nm in strong acid without any change in the absorption spectrum.

Inner-filter effects

Fluorescence intensity will be reduced by the presence of any compound which is capable of absorbing a portion of either the excitation or emission energy. At high concentrations this can be caused by absorption due to the fluorophore itself. More commonly, particularly when working with tissue or urine extracts, it is the presence of relatively large quantities of other absorbing species that is troublesome. The purpose of extraction procedures is usually to eliminate such species so that the final measurement is made upon a solution essentially similar to the standard.

Quenching

Decrease of fluorescence intensity by interaction of the excited state of the fluorophore with its surroundings is known as quenching and is fortunately relatively rare. Quenching is not random. Each example is indicative of a specific chemical interaction, and the common instances are well known. Quinine fluorescence is quenched by the presence of halide ion despite the fact that the absorption spectrum and extinction coefficient of quinine is identical in 0.5M H₂SO₄ and 0.5M HCl.

References

1. *The luminescence of biological systems*, Johnson, F.H., Amer. Assoc. Adv. Sci., Washington, D.C. (1955).
2. *Fluorescence and phosphorescence analysts*, Hercules, D.M., Editor Wiley-Interscience Publishers, New York, London, Sydney (1965).
3. *Fluorometric analysis*, Konstantinova-Schlezing, M.A., Editor, Davis Publishing Co., New York (1965).
4. *Handbook of fluorescence spectra in aromatic molecules*, Berlman, L.B., Academic Press, New York, Vol. I (1965), Vol. II (1971).
5. *Fluorometric techniques in clinical pathology*, Phillips, R., et al, Progress in Clinical Pathology, Grune and Stratton, New York (1965).
6. *Biochemical fluorescence: concepts, vol. I*, Chen, R.F., et al, 408 (1965).
7. *Fluorescence, theory, instrumentation and practice*, Edited by Guilbault, G.G., published by Marcel Dekker, Inc., New York (1967).
8. *Guide to fluorescence literature*, Passwater, R.A., Plenum Press, New York, Vol. I (1967), Vol. II (1969).
9. *Fluorescence and phosphorescence of proteins and nucleic acids*, Koney, S.U., Plenum Press, New York (1967).
10. *Luminescence of organic substances*, Schmillen, A., et al, Hellwege Verlag, Berlin (1967).
11. *Photoluminescence of solutions*, Parker, C.A., Elsevier Publishing Co., New York (1968).
12. *Fluorescence assay in biology and medicine*, Udenfriend, S., Academic Press, Vol. I (1962), New York Vol. II (1969).
13. *Theory and interpretation of fluorescence and phosphorescence*, Becker R., Wiley-Interscience (1969).

14. *Instrumental methods of chemical analysis*, 3rd Edition, Ewing, G.W., McGraw-Hill Book Co. (1969).
15. *Fluorimetric assay of enzymes*, Roth, M., Methods of Biochemical Analyses Vol. 17, David Glick, Editor Wiley Interscience, New York (1969).
16. *Luminescence and biophysics of cells*, Barenboim, G.M., et al, Plenum Press, New York (1969).
17. *Fluorescence analysis: a practical approach*, While; C.E., et al, Marcel Dekker (1970).
18. *Fluorescence spectroscopy: an introduction for biology and medicine*, Pesce, A.J., et al, Marcel Dekker (1971).
19. *Fluorometric analysis*, Weissler, A., et al, Standard methods of chemical analysis- Welcher, Editor D.Van Nostrand Co., Princeton, N.J. (1970).
20. *Biochemical fluorescence: concepts, vol. II*, Chen, R.F., et al, M. Dekker, New York (1970) 535 pp.
21. *Luminescence spectrometry in analytical chemistry*, Winefordner, J.D., et al. Wiley-Interscience Publishers, New York (1972).
22. *Methods In pharmacology, vol. II, physical techniques*, Chignell, C.F., Appleton-Crofts (1972).
23. *Practical fluorescence: theory, methods and techniques*, Guilbault, G.G., Marcel Dekker (1973).
24. *Fluorometric techniques in clinical chemistry*, Elevitch, F.R., Little Brown & Co. (1973).
25. *Modern fluorescence spectroscopy*, Wehry E.L., Ed; Plenum Press, New York (1976), Vol. I 238pp.
26. *Excited states of biological molecules*, Birks, J.B., Ed; John Wiley, London, (1976) 652 pp.

27. *Modern fluorescence spectroscopy*, Wehry, E.L., Ed. Plenum Press, New York (1976), Vol. 11459 pp.
28. *Physical Biochemistry-applications to biochemistry and molecular biology*, Freifelder, D., W. H. Freeman & Co. (1976).
29. *Fluorescence and phosphorescence spectroscopy: physiochemical principles and practice*, Schulman, S.G., Pergamon, Elmsford, New York (1977).
30. *Molecular fluorescence spectroscopy*, Guilbault, G.G., Cooper Anal. Chem. 8, 71-205, (1977), Svehlag. Ed; Elsevier.
31. *Developments in instrumentation and techniques*, West, M.A., from Photochemistry Vol. Chem. Soc. London.
32. *The handbook of derivatives for chromatography*, Blau, K., King, G., Heyden & Son Ltd. (1977).
33. *Standardization & fluorescence spectrometry*, Miller, G.N., Ed, Chapman and Hall, 1981.
34. *Fluorescence detection in liquid chromatography*, Rhys-Williams, A.T., PerkinElmer Ltd.
35. *Fluoroimmunoassay-a review of present methods*, Rhys-Williams, A.T., PerkinElmer Ltd.
36. *An introduction to phosphorescence spectroscopy*, Rhys-Williams, A.T., PerkinElmer Ltd.
37. *Nomenclature, symbols, units and their usage in spectrochemical analysis - VI molecular luminescence spectroscopy*, Melhuish, W.H., Zander, M., Pure App. Chem. 53, 1953, 1981.